

**HYPER-FAST
GLASS PASSIVATED RECTIFIER**

**REVERSE VOLTAGE – 600Volts
FORWARD CURRENT – 8.0 Ampere**

FEATURES

- Soft, Hyper fast switching capability
- Specially suited for critical mode Power Factor Corrections.
- High reliability and efficiency

MECHANICAL DATA

- Case: JEDEC TO-220AC
- Case Material: Plastic material, UL flammability classification 94V-0
- Moisture Sensitivity: Level 1 per J-STD-020C
- Terminals: Lead Free Plating
- Polarity indicator: As marked on the body
- Weight: 0.06 ounces, 2.24 grams
- Component in accordance to RoHs 2002/95/EC
- Maximum mounting torque = 0.5 N.m (5.1 Kgf.cm)

TO-220AC

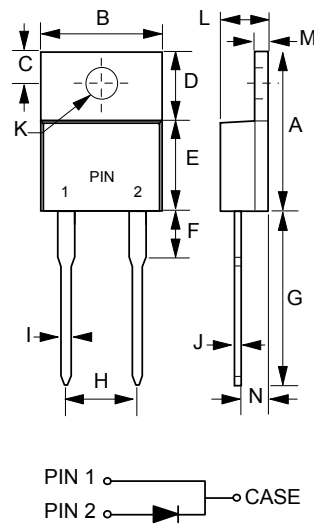

TO-220AC		
DIM.	MIN.	MAX.
A	14.40	15.20
B	9.65	10.67
C	2.54	3.43
D	5.84	6.86
E	8.26	9.28
F	-	4.20
G	12.70	14.73
H	4.83	5.33
I	0.51	1.14
J	0.30	0.64
K	3.53 \varnothing	4.09 \varnothing
L	3.56	4.83
M	1.14	1.40
N	2.03	2.92

All Dimensions in millimeter

MAXIMUM RATINGS AND ELECTRICAL CHARACTERISTICS

Ratings at 25°C ambient temperature unless otherwise specified.

Parameter			Symbol	LTTH806SD	Unit	
Maximum Repetitive Peak Reverse Voltage			V_{RRM}	600	V	
Average Rectified Output Current			I_F	8.0	A	
Forward Voltage (1)	$I_F=8.0A$	$T_j=25^\circ C$	V_F	3.4	V	
Reverse Leakage Current	$V_R=600V$	$T_j=25^\circ C$ $T_j=125^\circ C$	I_R	15 200	μA	
Reverse recovery time	$I_F=0.5A$ $I_{rr}=0.25A$ $I_R=1.0A$	$T_j=25^\circ C$	t_{rr}	21	ns	
Thermal characteristics (GBD)			Symbol	Value	Unit	
Non Repetitive Forward Surge Current		$t_p=10ms$	I_{FSM}	60	A	
Operation and Storage temperature range			T_J, T_{STG}	-55 to +175	$^\circ C$	
Typical thermal resistance, Junction to Ambient (2)			$R_{\theta JA}$	7.0	$^\circ C/W$	
Typical thermal resistance, Junction to Case (2)			$R_{\theta JC}$	2.8	$^\circ C/W$	
Typical thermal resistance, Junction to Lead (2)			$R_{\theta JL}$	3.5	$^\circ C/W$	
Dynamic electrical characteristics (GBD)			Symbol	Typical	Max.	
Reverse recovery time	$I_F=1A$, $dI_F/dt=-200A/\mu s$, $V_R=30V$	$T_j=25^\circ C$	t_{rr}	12	18	ns
Reverse recovery current	$I_F=8 A$, $dI_F/dt=-200A/\mu s$, $V_R=200V$	$T_j=25^\circ C$	I_{RM}	1.8	2.2	A
Reverse recovery charges		$T_j=125^\circ C$		5	6.0	
		$T_j=25^\circ C$	Q_{rr}	60	---	nC
		$T_j=125^\circ C$		220	---	

Note :

- (1) 300us Pulse Width, 2% Duty Cycle.
- (2) Thermal Resistance test performed in accordance with JESD-51. R_{thj-L} is measured at the PIN 2, R_{thj-C} is measured at the top centre of body.
- (3) GBD means Guaranteed By Design, the spec is basically follow designer simulation.

REV. 12, Sep-2012, KTGA25

FIG.1- FORWARD CURRENT DERATING CURVE

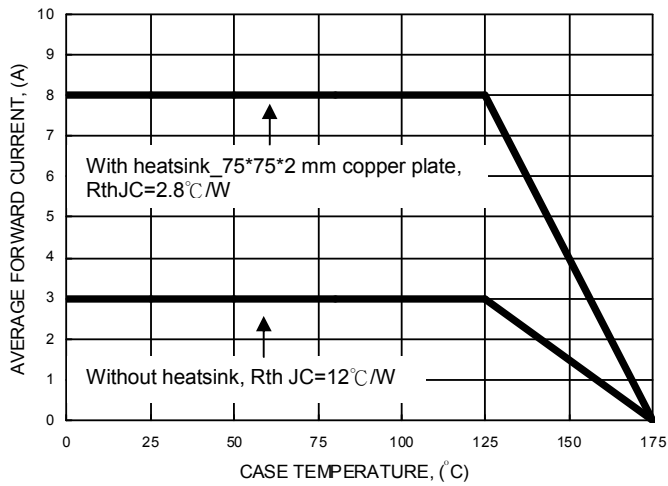

FIG.2- MAXIMUM NON-REPETITIVE SURGE CURRENT

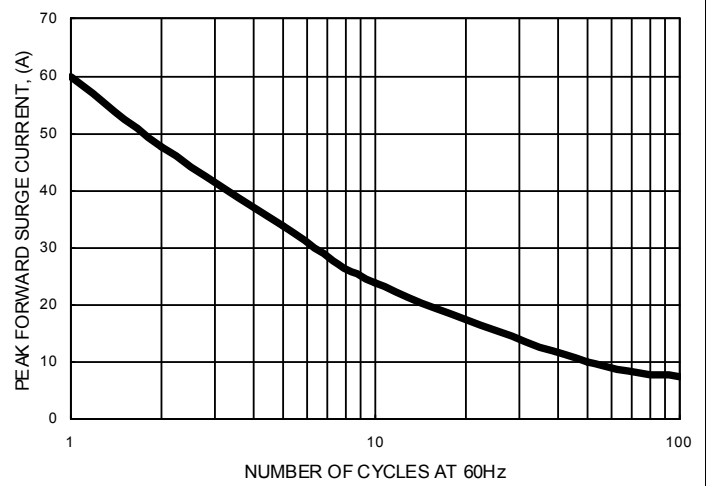

FIG.3- TYPICAL FORWARD CHARACTERISTICS

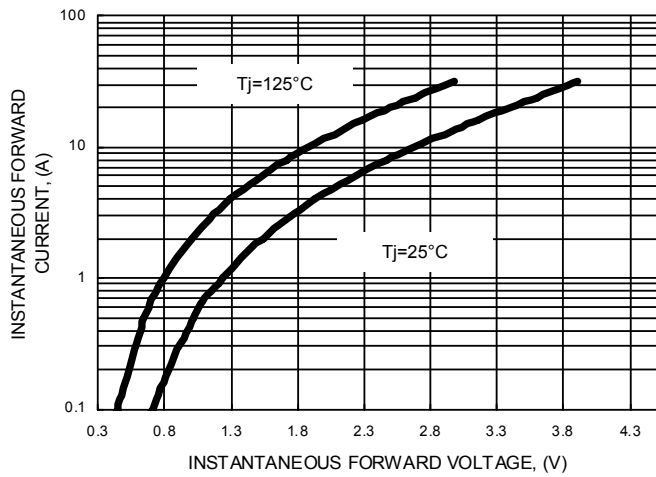

FIG.4- TYPICAL JUNCTION CAPACITANCE

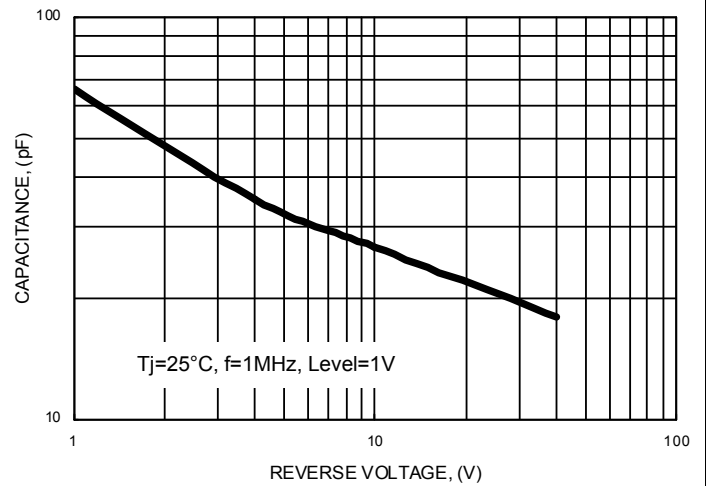

FIG.5- TYPICAL REVERSE CHARACTERISTICS

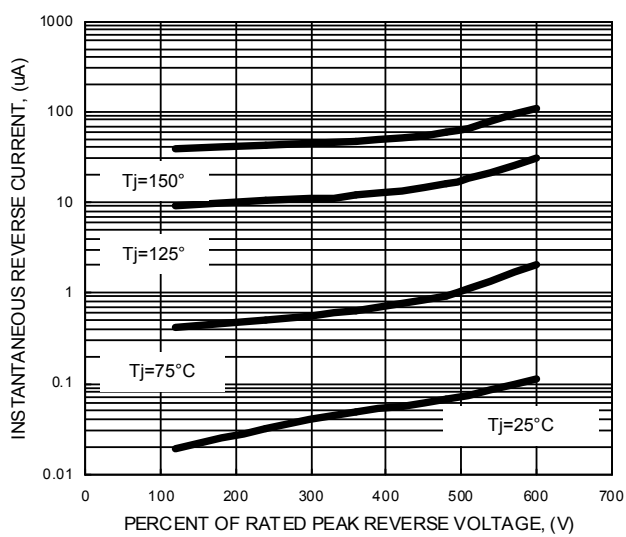
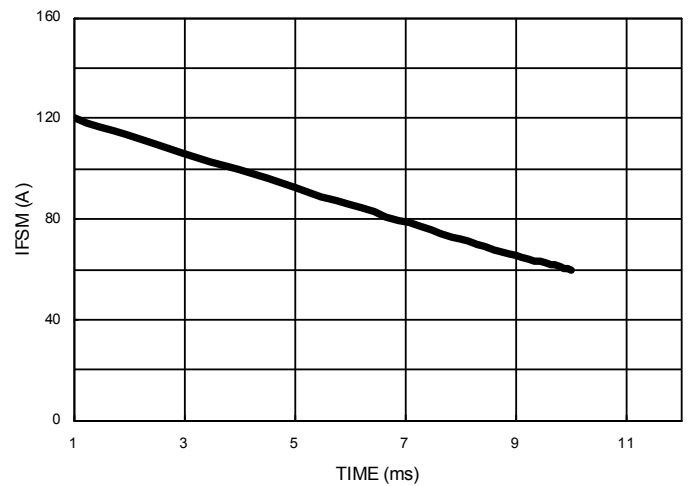

FIG.6- IFSM CAPABILITY CURVE



Important Notice and Disclaimer

LSC reserves the right to make changes to this document and its products and specifications at any time without notice. Customers should obtain and confirm the latest product information and specifications before final design, purchase or use.

LSC makes no warranty, representation or guarantee regarding the suitability of its products for any particular purpose, nor does LSC assume any liability for application assistance or customer product design. LSC does not warrant or accept any liability with products which are purchased or used for any unintended or unauthorized application.

No license is granted by implication or otherwise under any intellectual property rights of LSC.

LSC products are not authorized for use as critical components in life support devices or systems without express written approval of LSC.