

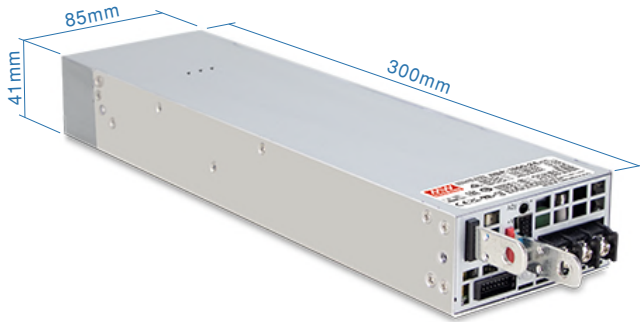

1600W AC/DC High Reliable Industrial Enclosed Type Power Supply **NSP-1600** series

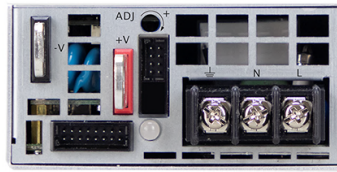

Front



Back

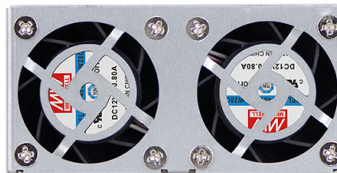

■ Features

- 90~264Vac input with PFC
- Output voltage 40~125% programmable (15~125% by request)
- Built-in CANBus protocol
- -20~+70°C wide range operation temperature
- Built-in constant current limiting circuit
- High efficiency up to 92.5%
- Built-in remote ON-OFF control / Remote Sense / 12Vaux power / DC OK signal / OTP alarm signal
- Built-in intelligent fan speed control
- Protections: Short circuit / Overload / Over voltage / Over temperature
- Design refer to SEMI F47 at 200Vac
- 5 years warranty

■ Applications

- Factory control or automation apparatus
- Test and measurement instrument
- Laser related machine
- Aging facility
- Digital broadcasting
- Constant current source

■ GTIN CODE

MW Search: <https://www.meanwell.com/serviceGTIN.aspx>

■ Description

NSP-1600 is a 1.6KW single output enclosed type AC/DC power supply with a 1U low profile and a high power density up to 25W/inch³. This series operates for 90~264Vac input voltage and offers the models with the DC output mostly demanded from the industry. Each model is cooled by the thermostatically controlled fan. Moreover, NSP-1600 provides vast design flexibility by equipping various built-in functions such as the output programming, remote ON-OFF control, auxiliary power, etc.

■ Model Encoding

NSP - 1600 - 48

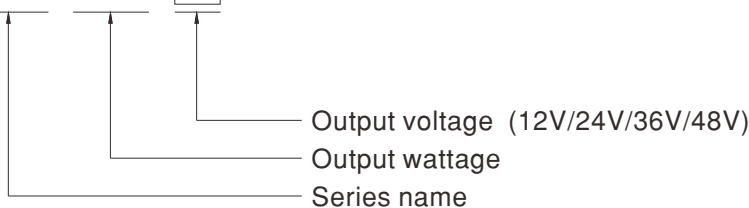

SPECIFICATION		NSP-1600-12	NSP-1600-24	NSP-1600-36	NSP-1600-48
OUTPUT					
DC VOLTAGE		12V	24V	36V	48V
RATED CURRENT		125A	67A	44.5A	33.5A
CURRENT RANGE		0 ~ 125A	0 ~ 67A	0 ~ 44.5A	0 ~ 33.5A
RATED POWER		1500W	1608W	1602W	1608W
RIPPLE & NOISE (max.)	Note.2	150mVp-p	200mVp-p	250mVp-p	300mVp-p
VOLTAGE ADJ. RANGE		11.5 ~ 15V	23.5 ~ 30V	35.5 ~ 45V	47.5 ~ 58.8V
VOLTAGE TOLERANCE	Note.3	±1.0%	±1.0%	±1.0%	±1.0%
LINE REGULATION		±0.5%	±0.5%	±0.5%	±0.5%
LOAD REGULATION		±0.5%	±0.5%	±0.5%	±0.5%
SETUP, RISE TIME		1500ms, 60ms/230Vac at full load			
HOLD UP TIME (Typ.)		16ms / 230Vac at 70% load	10ms / 230Vac at full load		
INPUT					
VOLTAGE RANGE	Note.4	90 ~ 264Vac 250 ~ 400Vdc			
FREQUENCY RANGE		47 ~ 63Hz			
POWER FACTOR (Typ.)		0.97/230Vac at full load			
EFFICIENCY (Typ.)		89%	91%	91.5%	92.5%
AC CURRENT (Typ.)	Note.4	14A/115Vac 8A/230Vac	15A/115Vac 8.5A/230Vac		
INRUSH CURRENT (Typ.)		COLD START 35A/230Vac			
LEAKAGE CURRENT		<2mA / 230Vac			
PROTECTION					
OVERLOAD		105 ~ 115% rated output power Protection type : Constant current limiting, unit will shut down o/p voltage after 5 sec. After O/P voltage falls, re-power on to recover			
OVER VOLTAGE		15.75 ~ 18.75V	31.5 ~ 37.5V	47.2 ~ 56.3V	63 ~ 75V
OVER TEMPERATURE		Shut down o/p voltage, recovers automatically after temperature goes down			
FUNCTION					
OUTPUT VOLTAGE PROGRAMMABLE(PV)		Adjustment of output voltage is allowable to 40 ~ 125%(12V: 60~125%) of nominal output voltage ; 15~125% by request. Please refer to the Function Manual.			
REMOTE CONTROL		By electrical signal or dry contact Power ON:short Power OFF:open. Please refer to the Function Manual			
REMOTE SENSE		Compensate voltage drop on the load wiring up to 0.5Vdc. Please refer to the Function Manual			
AUXILIARY POWER		12Vaux @ 0.8A			
ALARM SIGNAL		Isolated signal output for T-alarm and DC OK			
CANBus INTERFACE		Communication provides functions such as control, setting and monitoring			
FAN NOISE (Typ.)	Note.6	Built-in intelligent fan speed control detect by PSU'S internal temperature			
		10% load with Ta=25°C	38dB	38dB	38dB
		70% load with Ta=25°C	45dB	38dB	38dB
ENVIRONMENT					
WORKING TEMP.		-20 ~ +70°C (Refer to "Derating Curve")			
WORKING HUMIDITY		20 ~ 90% RH non-condensing			
STORAGE TEMP., HUMIDITY		-40 ~ +85°C, 10 ~ 95% RH non-condensing			
TEMP. COEFFICIENT		±0.03%/°C (0 ~ 50°C)			
VIBRATION		10 ~ 500Hz, 2G 10min./1cycle, 60min. each along X, Y, Z axes			
SAFETY & EMC (Note 7)					
SAFETY STANDARDS		UL62368-1, CAN/CSA C22.2 No. 62368-1, TUV BS EN/EN62368-1, BSMI CNS15598-1, BIS IS 13252(Part 1):2010/ IEC 60950-1 : 2005 (except for 48V), AS/NZS62368.1, EAC TP TC 004 approved			
WITHSTAND VOLTAGE		I/P-O/P:3KVac I/P-FG:2KVac O/P-FG:1.5KVac			
ISOLATION RESISTANCE		I/P-O/P, I/P-FG, O/P-FG:100M Ohms / 500Vdc / 25°C / 70% RH			
EMC EMISSION	Parameter	Standard		Test Level / Note	
	Conducted	BS EN/EN55032(CISPR32), CNS 15936		Class B(CISPR32)/Class A(CNS 15936)	
	Radiated	BS EN/EN55032(CISPR32), CNS 15936		Class A(CISPR32 & CNS 15936)	
	Harmonic Current	BS EN/EN61000-3-2		Class A	
	Voltage Flicker	BS EN/EN61000-3-3		----	
EMC IMMUNITY	BS EN/EN55024, BS EN/EN61000-6-2, BSMI CNS15598-1, design refer to SEMI F47 at 200Vac				
	Parameter	Standard		Test Level / Note	
	ESD	BS EN/EN61000-4-2		Level 3, 8KV air ; Level 2, 4KV contact	
	Radiated	BS EN/EN61000-4-3		Level 3	
	EFT / Burst	BS EN/EN61000-4-4		Level 3	
	Surge	BS EN/EN61000-4-5		Level 4, 2KV/Line-Line 4KV/Line-Earth	
	Conducted	BS EN/EN61000-4-6		Level 3	
	Magnetic Field	BS EN/EN61000-4-8		Level 4	
	Voltage Dips and Interruptions	BS EN/EN61000-4-11		>95% dip 0.5 periods, 30% dip 25 periods, >95% interruptions 250 periods	
OTHERS					
MTBF		684.7K hrs min. Telcordia SR-332 (Bellcore) ; 69.2K hrs min. MIL-HDBK-217F (25°C)			
DIMENSION		300*85*41mm (L*W*H)			
PACKING		1.8Kg;6pcs/11.3Kg/1.25CUFT			
NOTE					
1. All parameters NOT specially mentioned are measured at 230Vac input, rated load and 25°C of ambient temperature.					
2. Ripple & noise are measured at 20MHz of bandwidth by using a 12" twisted pair-wire terminated with a 0.1uf & 47uf parallel capacitor.					
3. Tolerance : includes set up tolerance, line regulation and load regulation.					
4. Derating may be needed under low input voltages. Please check the derating curve for more details.					
5. If use PV signal to adjust Vo, under certain operation conditions, ripple noise of Vo might go over rating defined in this specification.					
6. FAN noise test set up according to ISO-7779.					
7. The power supply is considered a component which will be installed into a final equipment. All the EMC tests are been executed by mounting the unit on a 720mm*360mm metal plate with 1mm of thickness. The final equipment must be re-confirmed that it still meets EMC directives. For guidance on how to perform these EMC tests, please refer to "EMI testing of component power supplies." (as available on https://www.meanwell.com/Upload/PDF/EMI_statement_en.pdf)					
8. The ambient temperature derating of 3.5°C/1000m with fanless models and of 5°C/1000m with fan models for operating altitude higher than 2000m(6500ft).					
※ Product Liability Disclaimer : For detailed information, please refer to https://www.meanwell.com/serviceDisclaimer.aspx					

Block Diagram

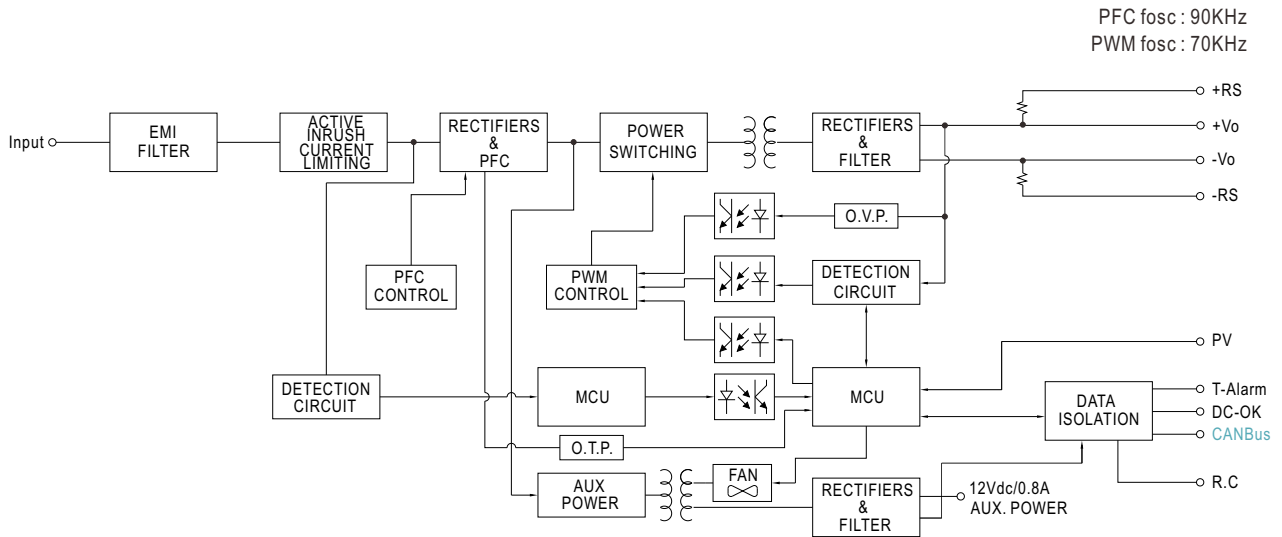

Static Characteristics

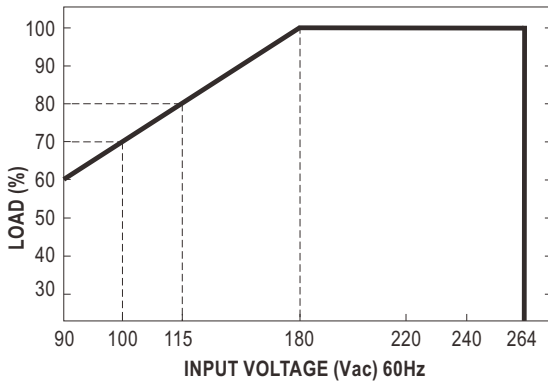

INPUT \ MODEL	12V	24V	36V	48V
180~264Vac	1500W 125A	1608W 67A	1602W 44.5A	1608W 33.5A
115Vac	1200W 100A	1286W 53.6A	1282W 35.6A	1286W 26.8A
100Vac	1050W 87.5A	1126W 46.9A	1121W 31.15A	1126W 23.45A
90Vac	900W 75A	965W 40.2A	961W 26.7A	965W 20.1A

Derating Curve

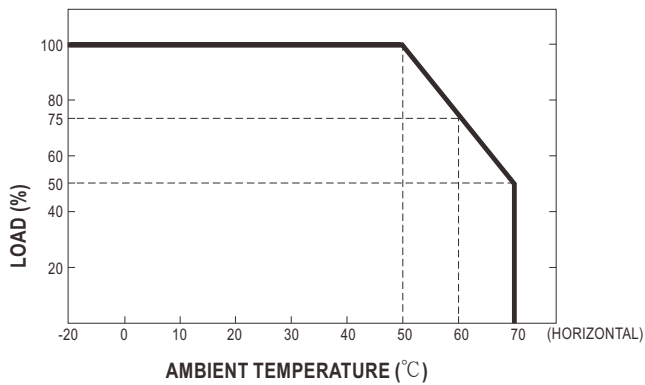

Efficiency vs Load (48V Model)

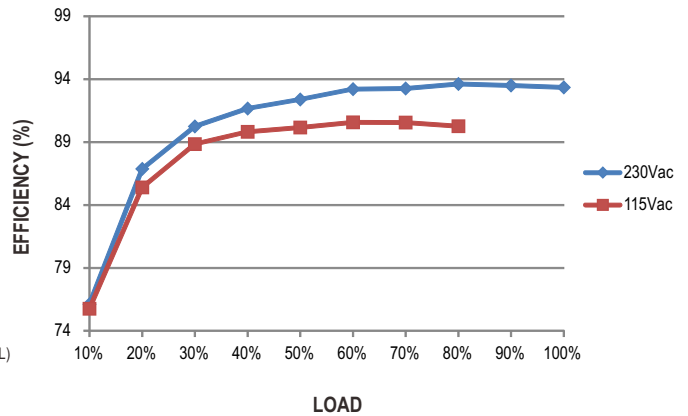

© The curve above is measured at 115/230Vac.

■ **Function Manual**

1. Output Voltage Programming (P.V)

※ In addition to the adjustment via the built-in potentiometer, the output voltage can be trimmed by applying External Voltage.

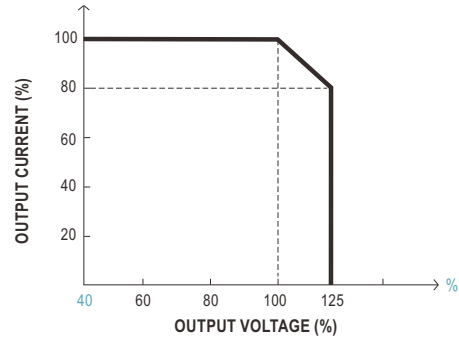
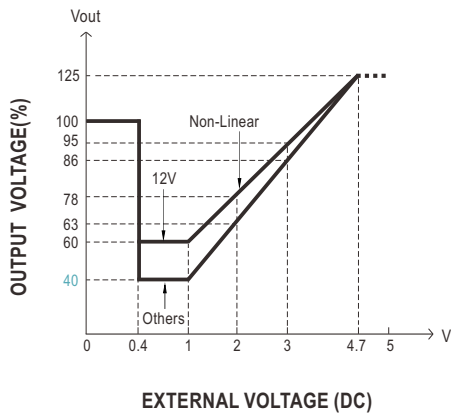
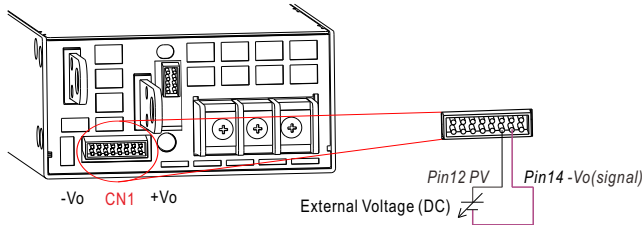

- ⊙ The rated current should change with the Output Voltage Programming accordingly.
- ⊙ For Remote Sense / Local Sense, please refer to "Voltage Drop Compensation" section.

2. Remote Control

※ The power supply can be turned ON/OFF individually or along with other units by using the "Remote Control" function.

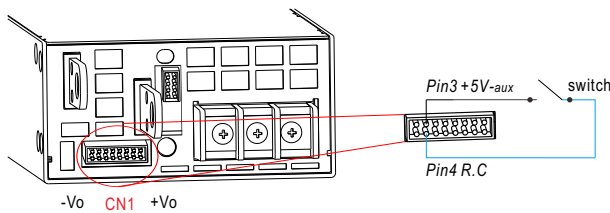

PSU Vo Status	Between +5V-aux(Pin 3) and R.C(Pin 4)
Power ON	Switch Short
Power OFF	Switch Open

R.C. by external switch.	R.C. by user's optocoupler control module.	R.C. by user's Relay control module.

3. Voltage Drop Compensation

3.1 Remote Sense

※ The Remote Sense compensates voltage drop on the load wiring up to 0.5Vdc

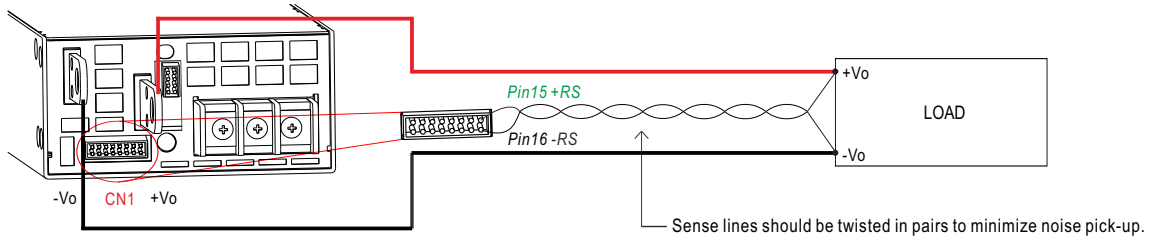

◎ The +RS signal should be connected to the positive terminal of the load whereas -RS signal to the negative terminal.

3.2 Local Sense

※ The +RS,-RS have to be connected to the +Vo(signal), -Vo(signal), respectively, as the following diagram, in order to get the correct output voltage if Remote Sense is not used.

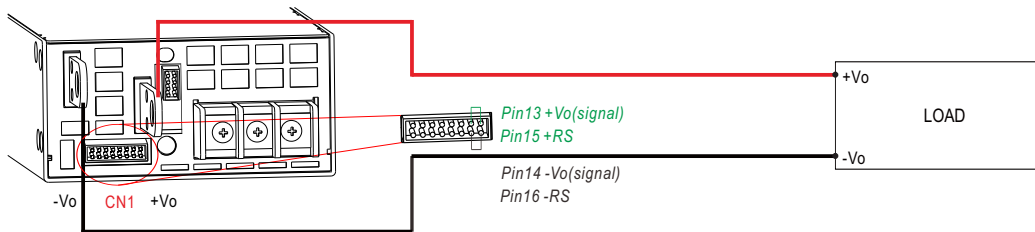

4. Alarm Signal Output

※ There are 2 alarm signals, DC OK and T-ALARM, in TTL signal form, on CN1. These signals are isolated from output. The maximum sink current is 10mA.

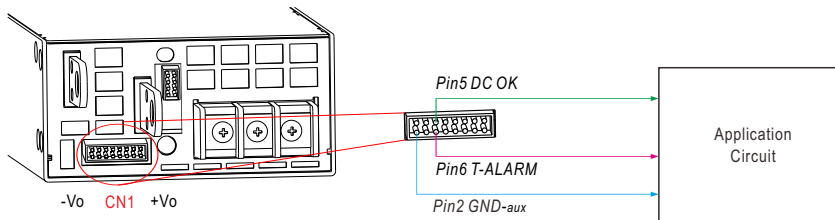

DC OK Fail signal	Power Supply Status
"High" > 3.5~5.5V	Vout ≦ 77%±5%
"Low" <-0.5~0.5V	Vout ≧ 80%±5%

T-ALARM	Power Supply Status
"High" > 3.5~5.5V	OFF(OTP or Fan Fail)
"Low" <-0.5~0.5V	ON(Normal Work)

5. CANBus Communication Interface

NSP-1600 supports CAN 2.0B with maximum 250KHz bus speed, allowing information reading, status monitoring, output trimming, etc. For details, please refer to the User's Manual.

Mechanical Specification

(Unit: mm , tolerance $\pm 0.5\text{mm}$)

Case No.296A

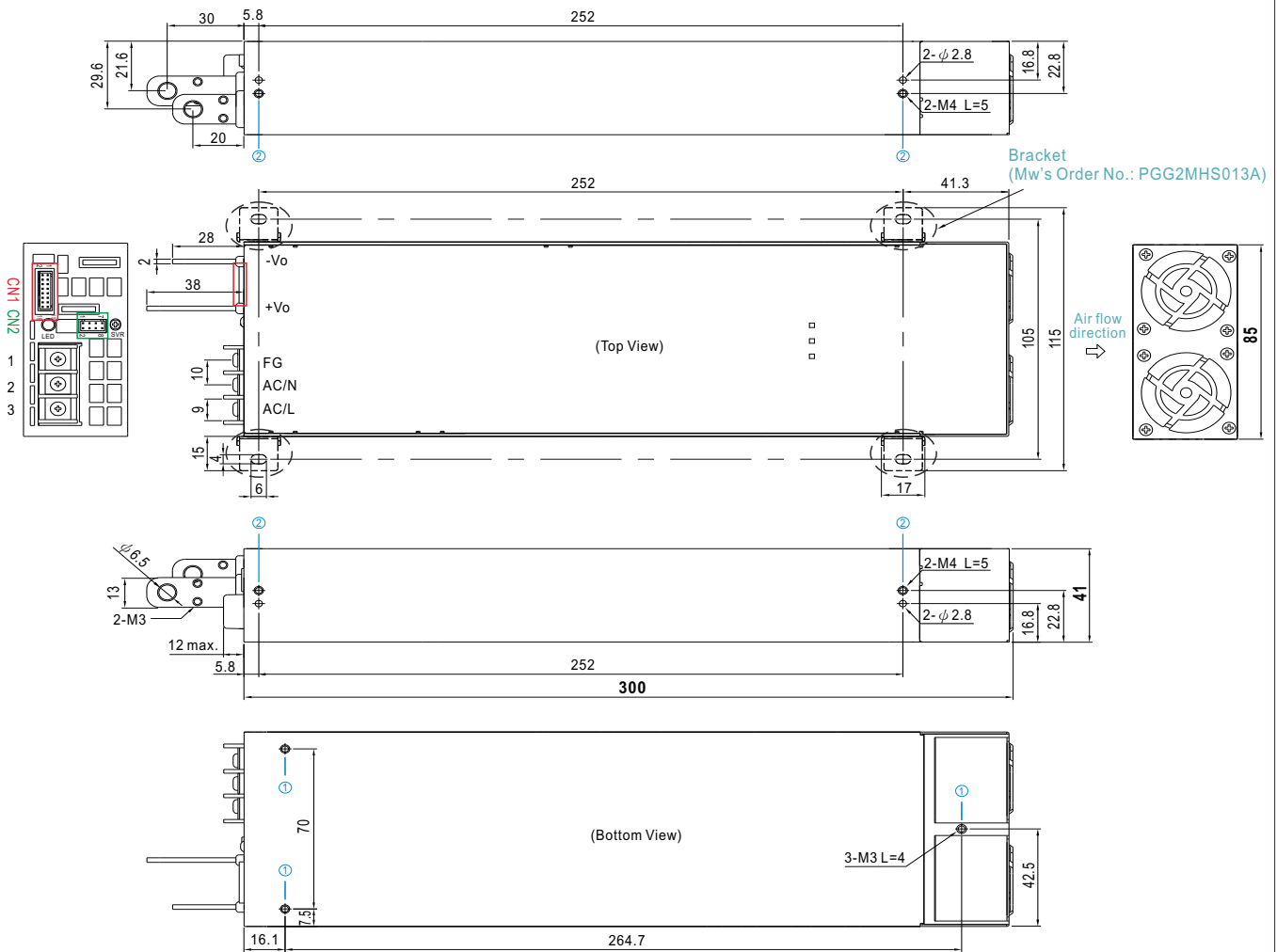

Mounting Instruction

Hole No.	Recommended Screw Size	MAX. Penetration Depth L	Recommended mounting torque
①	M3	4mm	6~8Kgf-cm
②	M4	5mm	7~10Kgf-cm

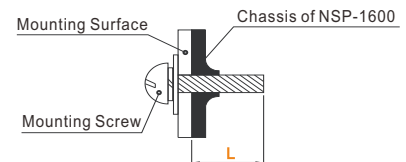

Control Pin No. Assignment(CN1) : HRS DF11-16DP-2DS or equivalent

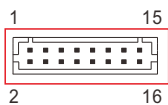

Mating Housing	HRS DF11-16DS or equivalent
Terminal	HRS DF11-16SC or equivalent

Pin No.	Function	Description
1	+12V-aux	Auxiliary voltage output, 10.6~13.2Vdc, referenced to GND-aux (pin2). The maximum load current is 0.8A. This output has the built-in "Oring diodes" and is not controlled by "Remote ON-OFF".
2	GND-aux	Auxiliary voltage output GND. The signal return is isolated from the output terminals (+Vo & -Vo).
3	+5V-aux	This pin is use for remote ON-OFF usage only.
4	R.C	The unit can turn the output ON/OFF by electrical signal or dry contact between Remote ON/OFF and +5V-aux. (Note.2) Short (4.5 ~ 5.5Vdc) : Power ON ; Open (-0.5 ~ 0.5Vdc) : Power OFF ; The maximum input voltage is 5.5Vdc.
5	DC-OK	High (3.5 ~ 5.5Vdc) : When the Vout $\leq 77\% \pm 5\%$. Low (-0.5 ~ 0.5Vdc) : When Vout $\geq 80\% \pm 5\%$. The maximum sourcing current is 10mA and only for output. (Note.2)
6	T-ALARM	High (3.5 ~ 5.5Vdc) : When the internal temperature exceeds the limit of temperature alarm, or when Fan fails. Low (-0.5 ~ 0.5Vdc) : When the internal temperature is normal, and when Fan works normally. The maximum sourcing current is 10mA and only for output(Note.2)
7,8,9	A0,A1,A2	CANBus interface address lines. (Note.1)
10,11	NC	Retain for future use.
12	PV	Connection for output voltage programming. (Note.1)
13	+Vo(Signal)	Positive output voltage signal. It is for local sense; it cannot be connected directly to the load.
14	-Vo(Signal)	Negative output voltage signal. It is for local sense and certain function reference; it cannot be connected directly to the load.
15	+RS	Positive sensing for remote sense.
16	-RS	Negative sensing for remote sense.

Note1: Non-isolated signal, referenced to [-Vo(signal)].

Note2: Isolated signal, referenced to [GND-aux].

※ LED Status Indicators

LED	Description
Green	The power supply functions normally.
Red	The LED will present a constant red light when the abnormal status (OTP, OLP, fan fail) arises.
Red (Flashing)	The LED will flash with the red light when the internal temperature reaches 60°C; under this condition, the unit still operates normally without entering OTP. (In the meantime, an alarm signal will be sent out through the CANBus interface.)

※ AC Input Terminal Pin No. Assignment

Pin No.	Assignment	Diagram	Screw thread	Maximum mounting torque
1	FG \perp		M3.5	8Kgf-cm
2	AC/N			
3	AC/L			

※ Control Pin No. Assignment(CN2) : HRS DF11-8DP-2DS or equivalent

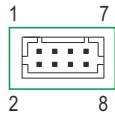

Mating Housing	HRS DF11-8DS or equivalent
Terminal	HRS DF11-**SC or equivalent

Pin No.	Function	Description
1,2,3,4	NC	For standard model: Retain for future use.
5,6	-Vo (Signal)	Negative output voltage signal. It is for local sense and certain function reference; it cannot be connected directly to the load.
7	CANH	For CANBus model: Data line used in CANBus interface. (Note)
8	CANL	For CANBus model: Data line used in CANBus interface. (Note)

Note: Isolated signal, referenced to [GND-aux].

■ Accessory List

No.	Item	Quantity	
1	Control function interface(CN1) mating wire along with NSP-1600 (standard accessory)	 HRS DF11-16DS or equivalent 	1pcs/per model
2	Bracket Mw's Order No.: PGG2MHS013A (By request accessory, should ordered seperately)		4pcs/per model (Please refer to Installation Diagram)



■ Installation Diagram

